

INTRODUCTION

Features	Benefits
Fast Performance at 100scans/per sec.	Increased productivity resulting in shorter checkout lines and better customer service
Multiple Interfaces On Board	Ensure flexible connectivity,allowing for host "future proofing"
Bright LED and beeper with adjustable volume	Multiple modes of confirmation ensure positive user feedback
Hands-free with stand (Optional)	Enables presentation scanning and easy switching between hands-held and handfree modes
Ergonomic design	Reduces user fatigue with sleek balanced form for maximum comfort and productivity
High-end Appearance Mould	Delicate and Exquisite Appearance bring you the enjoyment of you distinguished
Imported Laser Engine & CK push-button	10,000 hours reliability for the engine , 300,0000 times reliability for the push button
Superb scanning Ability	Enable to scan all the ID bar code , composite component bar code, colorful Bar code, bar code covered by thin film

Why do you choose our products?

1.Maximum Productivity at an Affordable price

Handheld laser bar code scanner form us deliverys performance features at an acceptably affordable price to made you buying decision easier than ever before .From the checkout line to the back room ,our products help you make the most of your application-specific solution in a variety of ways including :Transform your Retail ,Transportation&Logistics and Industrial Application.

2.Transform your Retail ,Transportation&Logistics and Industrial Application

Adding bar code scanning to your application-specific solution is convenient and flexible .You can configure the bar code scanner by scanning the bar code we offer to realize your wanted function in Retail ,Transportation&Logistics and Industry.

3.Create a More Productive Environment

Our handheld scanner offer a host of features at an economical price .Ease of use,performance and affordability combine to provide you with a powerful productivity tool.

Tables Of Contents

Introduction	1
Features.....	1
Why do you choose our products.....	1
Barcode Scanner Interface Installing and Removing	4-6
Multiscan Functions	7-8
Version No.....	7
Output Mode.....	7
Buzzer/Led.....	7
Image Setup.....	8
Add Code ID	8
Scanning Mode.....	8
Interface--KBW	8-9
PC Input Mode.....	8
Transmit speed.....	9
KBW Language	9
Interface--Serial-1	9-10
Baut Rate.....	9
Handshake Protocol.....	9-10
Interface--Serial--2	10
DATA BIT.....	10
END BIT.....	10
Parity Check.....	10
Interface--Wand	10-11
Barcode128.....	10-11
Speed.....	11
Bar Level.....	11
Code11.....	11
Code39.....	11
Barcode On/Off	11-13
Code93.....	11
Code128.....	12
CODABAR.....	12
Interleaved 2 of 5.....	12
Industrial 2 of 5.....	12
MSI/PLESSEY.....	12
UPC/EAB.....	13
Barcode Symbol Setup--1	13-14
Code11.....	13
Code39.....	13-14
Barcode Symbol Setup--2	14-15
Code39.....	14

Code128.....	14
CODABAR.....	15
Barcode Symbol Setup--3.....	15-16
CODABAR.....	15
Interleaved 2 of 5.....	15
Industrial 2 of 5.....	15-16
Barcode Symbol Setup--4.....	16-17
MSI/PLESSEY.....	16
UPC/EAB.....	16-17
Barcode Symbol Setup--5.....	17-18
UPC/EAB.....	18
Barcode Symbol Setup--6.....	18
UPC/EAB.....	18
Edit Setup Barcodes.....	18-19
MACRO/Special Keys Setup Barcodes.....	19
Termination String Setup Barcodes.....	19-20
Using The Advanced Setting Mode To Set Up	
The Bar code Scanner.....	21
Setup Category	22-23
Editing Keys.....	23-24
Option No.&Description.....	24-31
Appendix.....	32

BARCODE SCANNER INTERFACE CABLE INSTALLING AND REMOVING

Appearance:

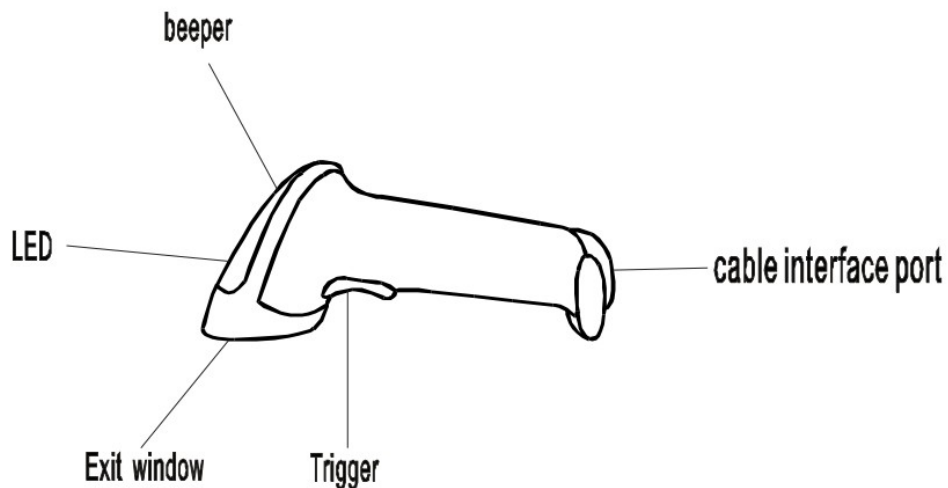

(figure 1)

Installing the interface cable

- 1.Plug the interface cable modular connector into the cable interface port on the bottom of the scanner handle(see figure2)
- 2.Gently tug the cable to ensure the connector is property secured
- 3.Connect the other end of the interface cable to the host

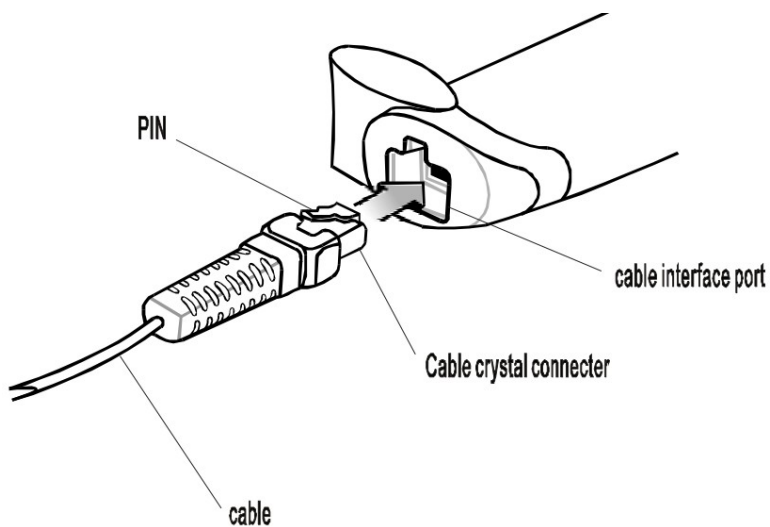

(figure 2)

Removing the interface cable

1. Unplug the installed cable's modular connector by depressing the connector clip with the tip of a screwdriver
2. Carefully slide out the cable
3. Follow the steps for the interface cable on page to connect a new cable

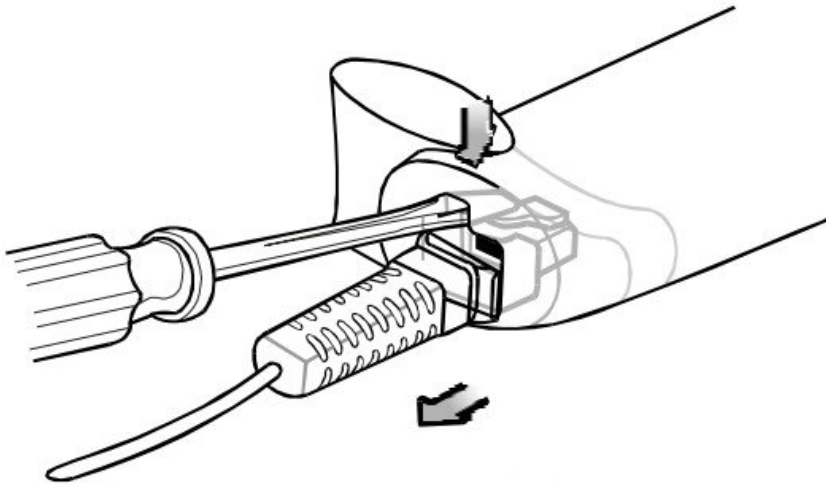

(figure 3)

Cable Connection

KBW Connection with Y-cable

1. Switch off the host and unplug the keyboard connector
2. Connect the host female DIN keyboard connector of the Y-cable to the keyboard
3. Connect the round male DIN connector of the Y-cable to the keyboard port on the host device
4. Switch on your host system. The buzzer and led of scanner will have the remind signal of all connections are secure

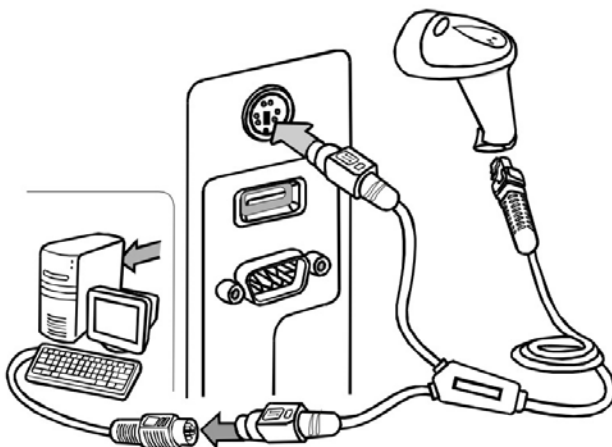

(figure 4)

RS-232 Direct Connection

1. Switch off the host
2. Connect the RS-232 interface cable to bottom of the scanner
3. Connect the other end of the interface cable to the serial port on the host
4. If the equipment haven't power supply, please use the 5V power supply to the cable
5. Switch on your host system. The buzzer and led of scanner will have the remind signal if all connections are secure

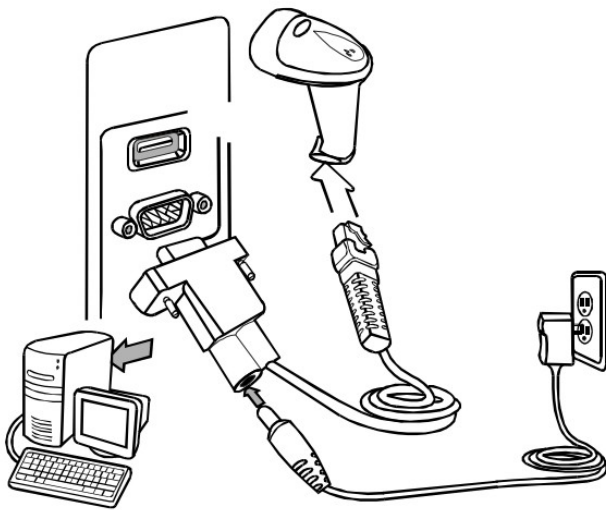

(figure 5)

USB connection

1. Connect the USD interface cable to the bottom of the scanner
2. Connect the other end of the interface cable to the host
3. The buzzer and LED of scanner will have the remind signal if all connections are secure
4. Windows will check the USB equipment automatically

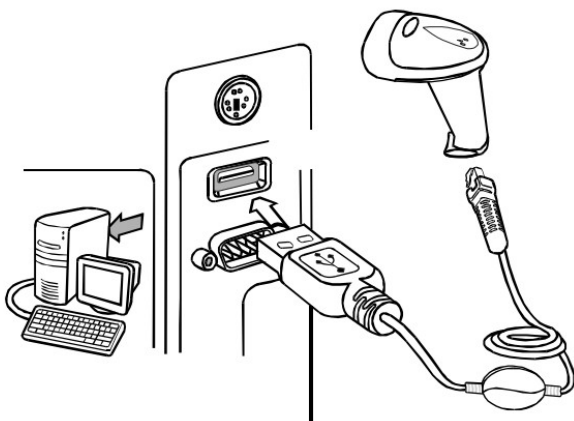

(figure 6)

Multiscan Functions

DISPLAY THE VERSION NO



RESTORE TO MANUFACTURER SETTING



OUTPUT MODE

KBW MODE



SERIAL MODE



WAND EMULATION MODE



RESET MODE



BUZZER/LED

MUTE



TURN ON



MEDIUM TONE



POWER MODE



IMAGE SETUP

DECODE OPTIONS REVERSE IMAGE-ENABLE



01391

DECODE OPTIONS REVERSE IMAGE- DISAABLE



01390

ADD CODE ID

BEFORE CLOSE BARCODE TO ADD ID



01400

BEFORE OPEN BARCODE TO ADD ID



01401

AFTER CLOSE BARCODE TO ADD ID



0B140

BEFORE OPEN BARCODE TO ADD ID



01402

SCANNING MODE

LASER/CCD MODE-RESET



013300

LASER/CCD MODE-SINGLE SCAN NO TRIGGER



013301

LASER/CCD MODE-MULTISCAN



013302

LASER/CCD MODE-MULTISCAN NO TRIGGER



013303

LASER/CCD MODE-AUTOMATIC CONTINUOUS SCAN



013304

LASER/CCD MODE-AUTOMATIC TWINKLE



013305

Interface – KBW

PC INPUT MODE

WEDGE MODE-AUTODETECT













000200

WEDGE MODE-SCAN SET2PASS THRU

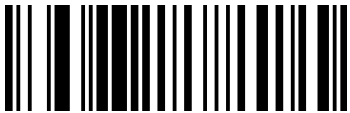
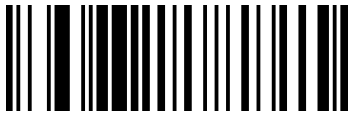

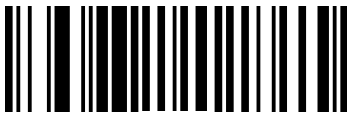
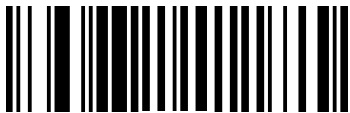
000204

Transmit Speed	
<p>TRANSMIT SPEED – 0</p>  <p>000000</p>	<p>TRANSMIT SPEED – 25</p>  <p>000025</p>
KBW LANGUAGE	
<p>KEYBOARD COUNTRY-USA</p>  <p>000500</p>	<p>KEYBOARD COUNTRY-GERMANY</p>  <p>000510</p>
<p>KEYBOARD COUNTRY-FRANCE</p>  <p>000509</p>	<p>KEYBOARD COUNTRY-RESET</p>  <p>000505</p>
Interface – Serial-1	
BAUD RATE	
<p>2400</p>  <p>000703</p>	<p>4800</p>  <p>000704</p>
<p>9600</p>  <p>000705</p>	<p>19200</p>  <p>000706</p>
HAND SHAKE PROTOCOL	
<p>SERIAL HANDSHAKE-NONE</p>  <p>001200</p>	<p>SERIAL HANDSHAKE-XON/OFF</p>  <p>001201</p>
<p>SERIAL HANDSHAKE-RTS/CTS</p>  <p>001202</p>	<p>SERIAL HANDSHAKE-ACK/NAK</p>  <p>001203</p>

SERIAL HANDSHAKE TIMEOUT-2 SECONDS



0013020

SERIAL HANDSHAKE TIMEOUT-5 SECONDS



0013050

Interface – Serial-2

DATA BIT

SERIAL DATA BITS-8



00081

SERIAL DATA BITS -7



00080

END BIT

SERIAL STOP BITS - 1



00090

SERIAL STOP BITS - 2



00091

PARITY CHECK

SERIAL PARITY - NONE



001000

SERIAL PARITY - ODD



001001

SERIAL PARITY - EVEN

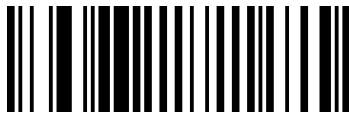

001002

SERIAL PARITY - MARK



001003

SERIAL PARITY - SPACE

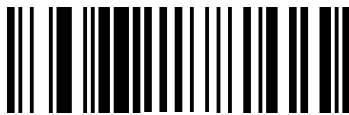

001004















SERIAL PARITY - RESET





























0B010















Interface – WAND

BARCODE 128

CODE 128 WAND EMULATION - ENABLE  00141	CODE 128 WAND EMULATION - DISABLE  00140
SPEED	
WAND EMULATION SPEED-FASTEST (0)  00150	WAND EMULATION SPEED-SLOWEST (3)  00153
BAR LEVEL	
WAND EMULATION-BAR=1(HIGH)  00161	WAND EMULATION-BAR=0(LOW)  00160
CODE 11	
CODE 11-ENABLE  01261	CODE 11 - DISABLE  01260
CODE 39	
CODE 39 ENABLE  00221	CODE 39 - DISABLE  00220
FULL ASCII ENABLE  00231	FULL ASCII DISABLE  00230
BARCODE On/Off	
CODE 93	
CODE 93 - ON  00621	CODE 93 - OFF  00620

CODE128	
CODE 128 - ON  00691	CODE 128 - OFF  00690
CODE 128 ISBT - ON  00701	CODE 128 ISBT - OFF  00700
CODABAR	
CODABAR - ON  008851	CODABAR - OFF  00850
INTERLEAVED 2 OF 5	
12 OF 5 -ON  00961	12OF5 - OFF  00960
INDUSTRIAL 2 OF 5	
ID2OF5- ON  01061	ID2OF5 - OFF  01060
MSI/PLESSEY	
MSI - ON  01151	MSI - OFF  01150

UPC/EAN	
UPC—A ON  00341	UPC—A OFF  00340
UPC—E ON  00351	UPC—E OFF  00350
EAN—13 ON  00361	EAN—13 OFF  00360
EAN—8 ON  00371	EAN—8 OFF  00370
BARCODE SYBOL Set Up - 1	
CODE 11	
CODE 11 ID CHARACTER 'm'  0131m	CODE 11 ID CHARACTER 'z'  0131z
CODE 11 LASER/CCD REDUNDANCY - ENABLE  01321	CODE 11 LASER/CCD REDUNDANCY - DISABLE  01320
CODE 39	
CODE 39 SS CHAR - NONE  002700	CODE 39 SS CHAR '+'  002704

<p>CODE 39 SEND STAR/STOP CHARS ENABLE</p>  <p>00281</p>	<p>CODE 39 SEND START/STOP CHARS DISABLE</p>  <p>00280</p>
<p>CODE 39 ID CHARACTER 'a'</p>  <p>0031a</p>	<p>CODE 39 ID CHARACTER 'z'</p>  <p>0031Z</p>
<p>CODE 39 LASER/CCD REDUNDANCY ENABLE</p>  <p>00331</p>	<p>CODE 39 LASER/CCD REDUNDANCY DISABLE</p>  <p>00330</p>
<p>BARCODE SYBOL Set Up - 2</p>	
<p>CODE 93</p>	
<p>CODE 93 ID CHARACTER 'h'</p>  <p>0066h</p>	<p>CODE 93 ID CHARACTER 'z'</p>  <p>0066Z</p>
<p>CODE 93 LASER/CCD REDUNDANCY-ENABLE</p>  <p>00681</p>	<p>CODE 93 LASER/CCD REDUNDANCY-DISABLE</p>  <p>00680</p>
<p>CODE 128</p>	
<p>CODE 128 ID CHARACTER 'g'</p>  <p>0081g</p>	<p>CODE 128 ID CHARACTER 'z'</p>  <p>0081Z</p>
<p>CODE 128 LASER/CCD REDUNDANCY-ENABLE</p>  <p>00841</p>	<p>CODE 128 LASER/CCD REDUNDANCY- DISABLE</p>  <p>00840</p>

CODABAR

CODABAR SEND START/STOP CHARS-ENABLE



00861

CODABAR SEND START/STOP CHARS-DISABLE



00860

CODABAR WIDE GAPS ALLOWED-ENABLE

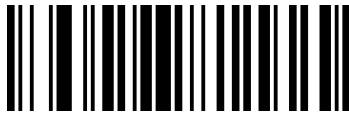

00901

CODABAR WIDE GAPS ALLOWED- DISABLE



00900

BARCODE SYBOL Set Up - 3

CODABAR

CODABAR ID CHARACTER-k



0094k

CODABAR ID CHARABTER-z



0094Z

CODABAR LASER/CCD REDUNDANCY-ENABLE



00951

CODABAR LASER/CCD REDUNDANCY-DISABLE



00950

Interleaved 2 of 5

12OF5 ID CHARACTER-i



0104i

12OF5 ID CHARACTER-z



0104Z

12OF5 LASER/CCD REDUNDANCY-ENABLE



01051

CODABAR LASER/CCD REDUNDANCY-DISABLE



01050

Industrial 2 of 5

ID2OF5 ID CHARACTER-j



0113j

ID2OF5 CHARACTER-z

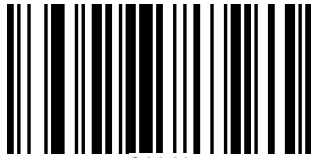
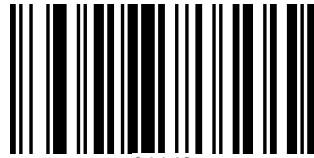

0113Z

<p>ID2OF5LASER/CCD REDUNDANCY-ENABLE</p>  <p>01141</p>	<p>ID2OF5LASER/CCD REDUNDANCY-DISABLE</p>  <p>01140</p>
---	---

BARCODE SYBOL Set Up - 4

MSI/PLESSEY

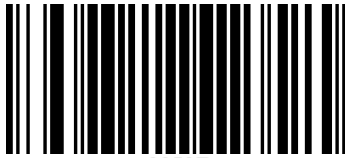
<p>MSI ISBN ID CHARACTER-f</p>  <p>0066h</p>	<p>MSI ISBN ID CHARACTER-z</p>  <p>0053Z</p>
---	--

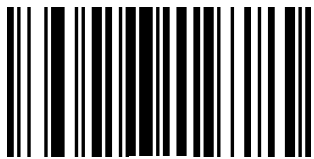
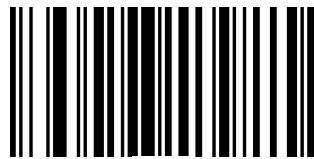
<p>MSI LASER/CCD REDUNDANCY-ENABLE</p>  <p>01251</p>	<p>MSI LASER/CCD REDUNDANCY-DISABLE</p>  <p>01250</p>
--	--

UPC/EAN

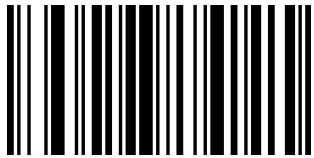
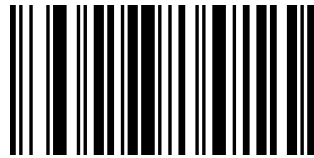
<p>EXPAND UPC-E TO UPC-A ENABLE</p>  <p>00381</p>	<p>EXPAND UPC-E TO UPC-A DISABLE</p>  <p>00380</p>
--	--

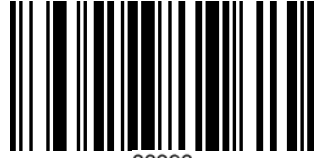
<p>EXPAND UPC-A TO EAN-13 ENABLE</p>  <p>00391</p>	<p>EXPAND UPC-ATO EAN-13 DISABLE</p>  <p>00390</p>
---	--

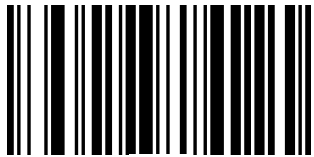
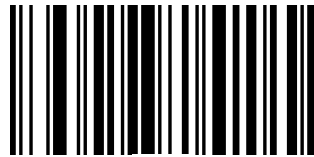
<p>CONVERT EAN-13 TO ISBN ENABLE</p>  <p>00481</p>	<p>CONVERT EAN-13 TO ISBN DISABLE</p>  <p>00480</p>
---	---

UPC-A ID CHARACTER-b



0049b

UPC-A ID CHARACTER-z

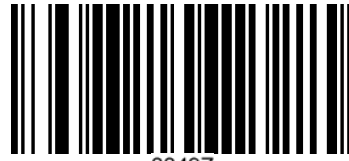

0049Z

BARCODE SYBOL Set Up—5

UPC/EAN

UPC-E ID CHARACTER-c

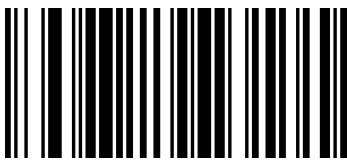

0050c

UPC-E ID CHARACTER-z

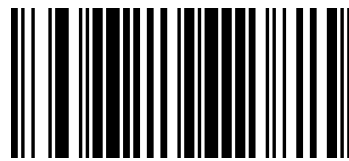

0050Z

EAN-13 ID CHARACTER-e

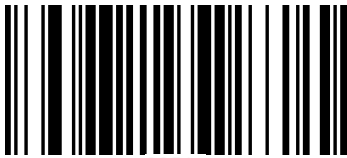

0051e

EAN-13 ID CHARACTER-z

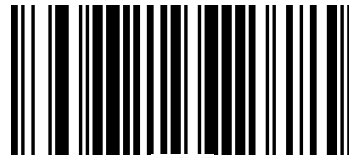

0051Z

EAN-8 ID CHARACTER -d

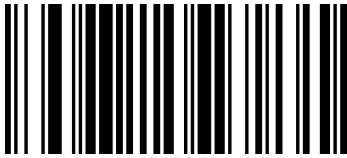

0052d

EAN-8 ID CHARACTER -z

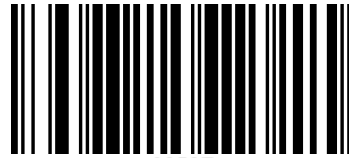

0052Z

ISBN ID CHARACTER -f

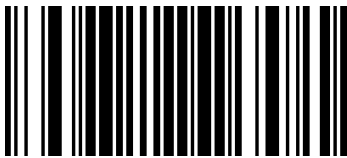

0053f

ISBN ID CHARACTER -z

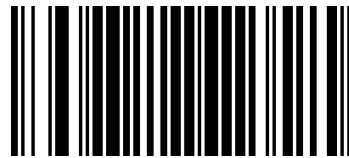

0053Z

UPC/EAN SUPPLEMENTS-DISABLE

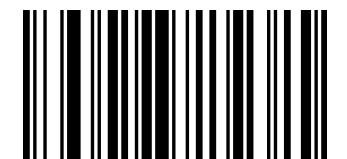





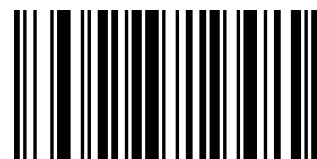



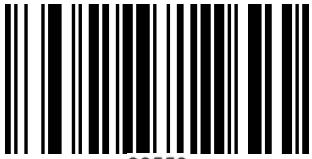
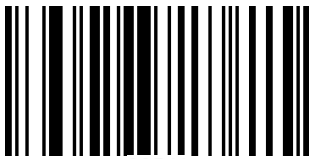
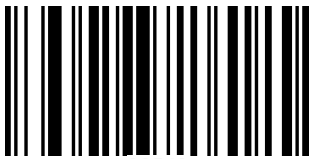











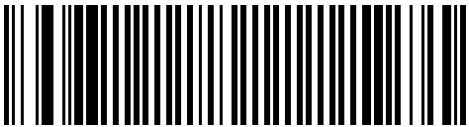
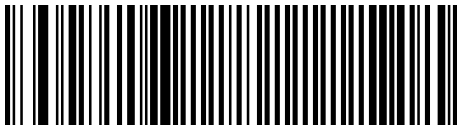

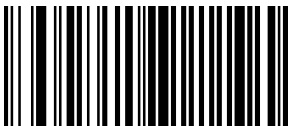
00550





UPC/EAN SUPPLEMENTS-2DIGIT ONLY

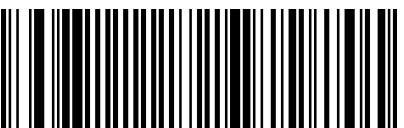

00551

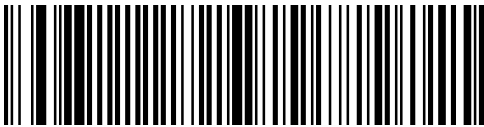
<p>UPC/EAN SUPPLEMENTS-5DIGIT ONLY</p>  <p>00552</p>	<p>UPC/EAN SUPPLEMENTS-2DIGIT ONLY</p>  <p>00553</p>
<p>BARCODE SYMBOL Set Up—6</p> <p>UPC/EAN</p>	
<p>UPC/EAN LASER/CCD REDUNDANCY ENABLE</p>  <p>00541</p>	<p>UPC/EAN LASER/CCD REDUNDANCY DISABLE</p>  <p>00540</p>
<p>EDIT SETUP BARCODES</p>	
<p>EDIT #1 – STRIP 1 LEADING CHARACTER ON ALL BARCODES THAT START WITH '12345'</p>  <p>02000101000000100000000112345</p>	<p>EDIT #1 - OFF</p>  <p>0B20001</p>
<p>EDIT #2 – STRIP 1 TRAILING CHARACTER</p>  <p>020002020000001</p>	<p>EDIT #2 - OFF</p>  <p>0B20002</p>
<p>EDIT #1 – FILTER LEADING SPACES</p>  <p>0200010300000032</p>	<p>EDIT #1 - OFF</p>  <p>0B20001</p>
<p>EDIT #1 – FILTER TRAILING SPACES</p>  <p>0200010400000032</p>	<p>EDIT #1 - OFF</p>  <p>0B20001</p>
<p>EDIT – FILTER CHARACTERS</p>  <p>0200000500000045</p>	<p>EDIT-DISABLE FILTERING OF ALL CHARS</p>  <p>0B20000050000045</p>

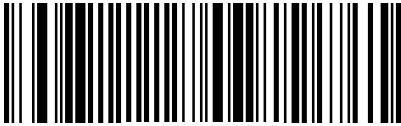
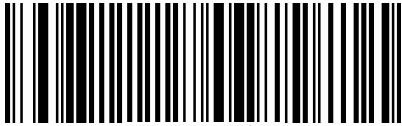
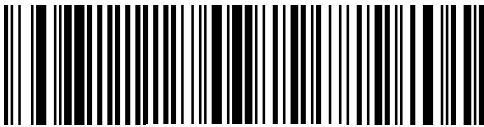
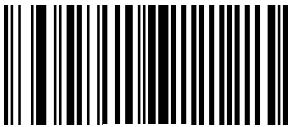
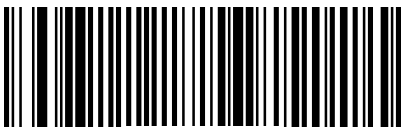
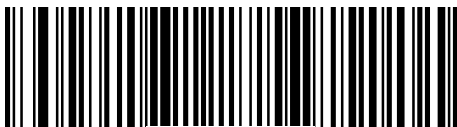
<p>EDIT-INSERT LEADING ZERO</p>  <p>020000060000000048</p>	<p>EDIT- DISABLE INSERT LEADING ZERO</p>  <p>0B20000060000000048</p>
<p>MACRO/SPECIAL KEYS SETUP BARCODES</p>	
<p>MACRO #1-FIND'1'AND PRPLACE WITH'ONE'</p>  <p>02010101011ONE</p>	<p>MACRO #1-DISABLED</p>  <p>0B20101</p>
<p>MACRO #2-FIND'2'AND REPLACE WITH 'TWO'FOR CODE 39 ONLY</p>  <p>02010203012TWO</p>	<p>MACRO #2-DISABLED 换</p>  <p>0B20102</p>
<p>MACRO-FIND'0'AND REPLACE WITH'A'</p>  <p>02010001010A</p>	<p>MACRO-FIND'0'AND REPLACE WITH'A'-DISABLE</p>  <p>0B2010001010A</p>
<p>SPECIAL KEY-MAP F3 TO'0'</p>  <p>0162048</p>	<p>SPECIAL KEY-DISABLE F3 KEY MAPPING</p>  <p>0B162</p>
<p>SPECIAL KEY-MAP KEYPAD ENTER TO '2'</p>  <p>0182050</p>	<p>SPECIAL KEY-DISABLE KEYPAD ENTER MAPPING</p>  <p>0B182</p>
<p>TERMINATION STRING SETUP BARCODES</p>	
<p>STRING#1-TERMINATION CHAR-CR</p>  <p>0202011000\$0D</p>	<p>STRING#1-TERMINATION-LF</p>  <p>0202011000\$0A</p>

<p>STRING#1-TERMINATION CR+LF</p>  <p>0202011000\$0D\$0A</p>	<p>STRING#1-DISABLED</p>  <p>0B20201</p>
<p>STRING#2-CODE128TERMINATION CHAR-CR</p>  <p>0202021080\$0D</p>	<p>STRING#2-CODE 128TERMINATION CHAR-LF</p>  <p>0202021080\$0A</p>
<p>STRING#2-CODE128 TERMINATION CHAR-CR+LF</p>  <p>0202021080\$0D\$0A</p>	<p>STRING#2-CODE 128TERMINATION CHAR-LF</p>  <p>0B20202</p>
<p>STRING-CODE 39 TERMINATION CHAR-TAB</p>  <p>0202001020\$09</p>	<p>STRING-CODE39 TERMINATION CHAR-TAB-REMOVED</p>  <p>0B202001020\$09</p>
<p>STRING- ALL CODES PREAMBLE-STX</p>  <p>0202002000\$02</p>	<p>STRING-ALL CODES POSTAMBLE-ETX</p>  <p>0202003000\$03</p>

Using The Advanced Setting Mode To Configure The Bar code

Scanner

The scanner can be configured by using the computer keyboard . The scanner must be installed and powered to enter the setting mode. Once the scanner is powered up ,please press and hold the following keys to finish setting

Left-Control ,Caps Lock, Right-Shift ,and Backspace¹

-or-

Left-Control,F2,Right-Shift,and Backspace²

Once you release the keys , the decoder will produce a series of beeps , change the LED to orange and display a message similar to the following on your display:

F1-F10=Options, Use ARROW KEYS to Toggle/Move ,ESC=Exit

To ensure that you have enough space on your command line for the scanner options to be displayed ,we recommend that you either have your command prompt located at the root directory or you load an editor with a new file. This will allow the scanner to use most of the characters on your computer display , for example,in Windows load ,Windows Write and in OS/2 load the Notepad program

Note : In addition to using your keyboard to enter Setup Mode you may scan the barcode below

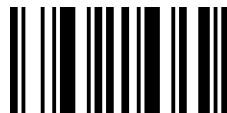

Enter Setup Mode

Note: This page is only for KBW interface reader , never execute any action if you are using RS232 interface reader